

1. Name and Parts

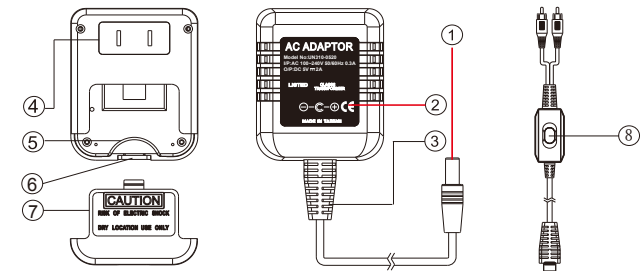

1. Camera Lens
2. Microphone*
3. Covert Power Cord
4. Two Prong Power Supply
5. SD Card Slot
6. Mini USB Port
7. Bottom Covert Piece
8. IR Sensor

*No microphones are available for USA market.

2. Package Content

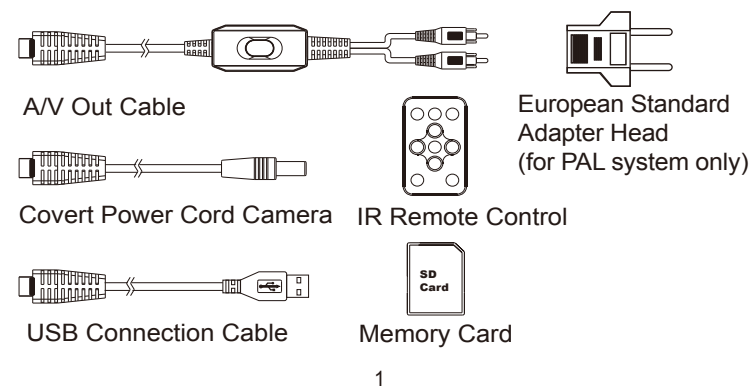

6. Recording Mode Setting

- 6.1. Default recording mode is set to "Motion Detect" and length of recording time is 1 minute.
- 6.2. To change length of recording time, go to "Recorder Setting" then enter "Motion Detect", press SETUP on Remote Control. Enter "Length of Recording" and select the length required(1 min, 3min, 5min).
- 6.3. If continuous recording function is required, enter "Recorder Setting" then select "Normal" recording mode.



7. Overwrite Recording(Loop Recording)

- 7.1. By default, overwrite recording function is turned off to avoid loss of important videos.
- 7.2. To enable overwrite recording, go to "Recorder Setting", enter either "Normal" or "Motion Detect" mode then press SETUP on remote control. Select "On" to activate Overwrite recording function.

3. Getting Started

- 3.1. Remove the bottom lid by sliding it downwards as shown in illustration 1
- 3.2. Insert memory card into slot as shown in illustration 2
- 3.3. Plug covert power cord camera onto the device.
- 3.4. Slide the bottom lid back to place.
- 3.5. As soon as you plug the charger into an electrical outlet it is ready to work.

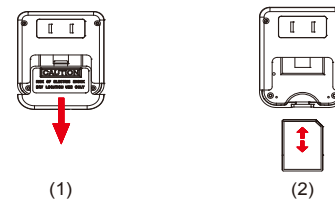

4. Power on DVR and Video Recording

- 4.1. Simply plug the charger DVR into an electrical outlet to power on the device.
- 4.2. Recording mode is preset on "Motion Detect", hence, recording will start as soon as a movement is detected.

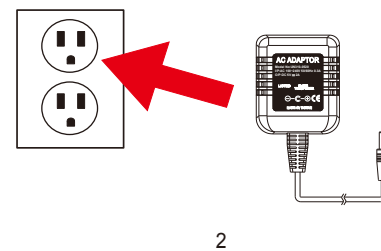

5. Time and Date Setting & On-Screen Display

- 5.1. Connect AV Out Cable to Mini USB port.
- 5.2. Connect the other end of the two RCA jacks to AV In port on monitor.
- 5.3. Power on monitor and select the corresponding video source.
- 5.4. Aim RF remote control to the IR Sensor, press stop button on the control to exit recording / preview page and enter menu page.(See illustration)
- 5.5. Navigate DVR menu by aiming RF remote control to IR Sensor and scroll down "Program Setting" then "Time Date Setting" to edit accordingly.
- 5.6. Time and Date information is automatically saved as soon as the charger is unplugged from electrical outlet.

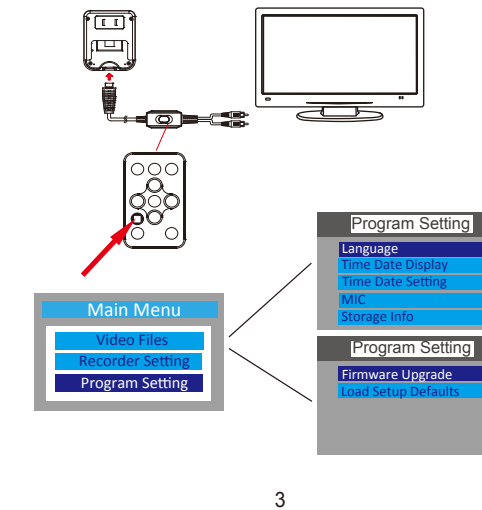

8. Viewing Videos

- 8.1. On monitor
With charger plugged to an electrical outlet and AV Out Cable connected to monitor, go to "Video Files" and select the video file you would like to watch then press on remote control.

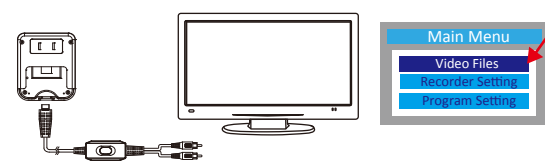

- 8.2. On computer
Unplug charger from electrical outlet, connect USB Cable to Mini USB Port on charger and the other end to an USB port on computer. The charger will be recognized as an external drive for use to replay the videos on computer. It is recommended to remove the memory card from the device and use a card reader to play videos on computer without interrupting recording task.

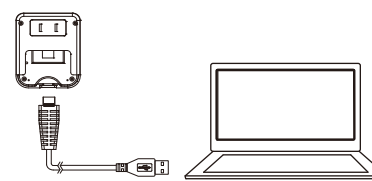

PV-AC30 Video Recorder in Adapter Design Quick Guide

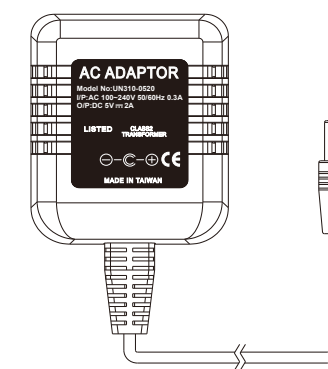

LawMate, innovation never stops

LawMate®